

SCX4 SERIES Commercial Lighting

SCX4-2FT-20W-MCT4-D-LUV-WH

WESTGATE
THE FUTURE IS HERE...AND IT'S QUITE BRIGHT!

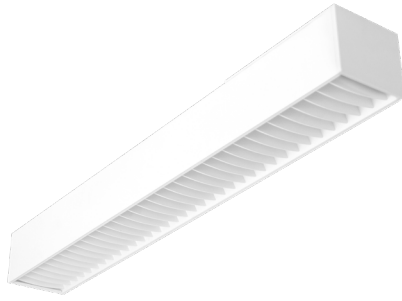

MCT4

Custom:



Selection:



Customer Name: _____

Project Name: _____

Note: _____

Type: _____

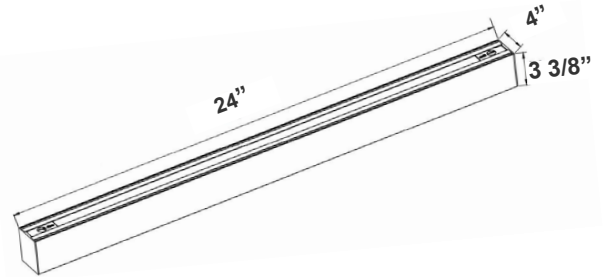

24"(L) x 4"(W) x 3 3/8"(H)

The SCX series offers the best and the most comprehensive selection for linear lighting. The various available lengths and widths allow the creation of the desired shape to elevate the areas aesthetics to a unique and modern look while providing an impressive illumination for the occupants. Ideal for, retail locations, offices, lobbies, conference rooms, reception areas, hallways, educational facilities, hotels, and restaurants. FEATURES: Superior Architectural Look Energy-efficient: Low Wattage Consumption & High Lumen Output Easier Wire Management & Install Variety of Mounting Options Multi Color Temperature (Selectable Switch Inside Fixture) Variety Of Factory Customizations Available

Features

- LED Superior Architectural Lights
- Seamless Linkable Linear Lighting System
- Optional Recessed & Wall Mounting Kits Available
- MCT: Multi Color Temperature (Selectable with Switch Inside Fixture)
- White Louver Lens-Direct (DOWN) Lighting

Technical Specifications

Electrical:

- Voltage: 120-277VAC 50/60Hz
- Wattage: 20W
- Power Factor: >0.95
- LPW: 104/ 117/ 106/ 107
- Total Harmonic Distortion: ≤ 20 %

Mechanical:

- Low Profile Modern Design
- Aluminum Housing With Matte White Finish
- Custom Colors Available
- Lens Snaps into Housing
- Make Different Connections Via T/L/X Joints on Both Ends
- Mounting Options: Surface, Suspended, Wall, Recessed
- IP Rating: IP54
- Operating Temperature: -13°F~104°F
- Adjustable Suspension Brackets Provided on Top of The Fixtures

Lighting:

- Dimmable: 0~10V Dimming
- Total Lumens: 2438LM
- Color Temperatures: 3000K/3500K/4000K/5000K
- Multi-CCT(Selectable with Switch Inside the Fixture)
- Color Rendering Index: CRI ≥ 80
- Up Light Option Available
- 50,000 Hours Rated Life
- 5-Year Warranty
- Beam Angle: 104.8°(H) x 100.5°(V)

Applications:

- Ideal for offices, hotels, corridors, saloons, libraries, meeting rooms, conference halls, and the best solution for modern lighting solutions
- It can be used in any indoor applications

Other Models:

• 30W | 3604LM | SSCX4-3FT-30W-MCT4-D • 40W | 4954LM | SCX4-4FT-40W-MCT4-D • 60W | 7208LM | SCX4-6FT-60W-MCT4-D • 80W | 9909LM | SCX4-8FT-80W-MCT4-D



Phone: (877) 805-2252 | Fax: (877) 805-2252
www.westgateimg.com |



WG-Z8-Y7-2Z

Photometrics: SCX4-2FT-20W-MCT4-D-LUV-WH

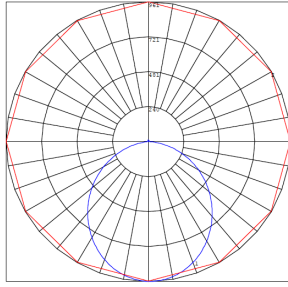
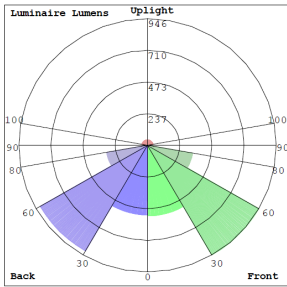

BUD Rating: B1-U2-G1

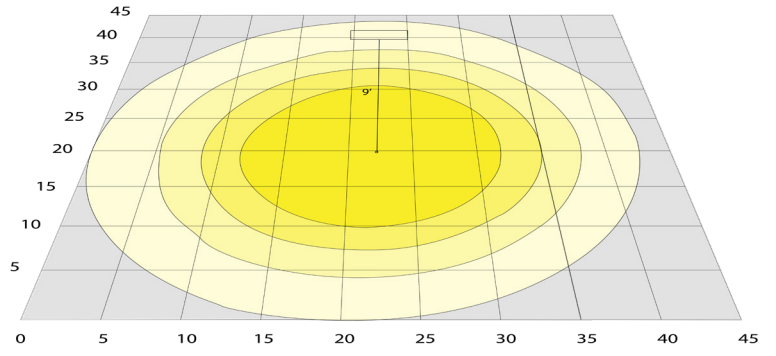

Area 45'x 45' Mounting Height: 9'

Other Views:



Side View



Front View



Back View

Performance Table: SCX4-2FT-20W-MCT4-D-LUV-WH

MODEL NO.	Wattage	Voltage	Lumens	Color Temp.	BUG Rating	LPW
SCX4-2FT-20W-MCT4-D-LUV-WH	20W	120~277V	2438LM	3000K 3500K 4000K 5000K	B1-U2-G1	107

Sample Ordering

Model	Size	Wattage	Color Temp.	Feature	Lens	Color
SCX4	2FT	20W	MCT4	D	LUV	WH

Accessories:

Blank = No Option For Accessories

SCL-CS1-6FT = ADJ. 6FT 1/16in SINGLE SUSPENSION CANOPY SET WITH KEYHOLE END CONNECTOR, NON-POWER SIDE

SCL-CS1P-6FT = ADJ. 6FT 1/16in SINGLE SUSPENSION CANOPY SET WITH KEYHOLE END CONNECTOR, POWER SIDE WITH SJTW18/5 WHITE CORD

SCL-CS1P-6FT-NC = ADJ. 6FT 1/16in SINGLE SUSPENSION CANOPY SET WITH KEYHOLE END CONNECTOR

SCL-GS10 = ADJ. 10FT 1/16in DOUBLE SUSPENSION CABLE WITH SINGLE KEYHOLE CONN., LOOP GRIPPER ON TOP

SCL-GS20 = ADJ. 20FT 1/16in DOUBLE SUSPENSION CABLE WITH SINGLE KEYHOLE CONN., LOOP GRIPPER ON TOP

SCL-6FT-SJTW18/5 = 6ft White Cord, SJTW 18 AWG 5-Conductor (Black, White, Green + Purple & Gray for 0-10V Dimming)

SCL-6FT-SJTW18/5-100FT = 100ft Roll of White Cord, SJTW 18 AWG 5-Conductor (Black, White, Green + Purple & Gray for 0-10V Dimming)

SCL-6FT-SJTW18/5-100FT-BK = 100ft Roll of Black Cord, SJTW 18 AWG 5-Conductor (Black, White, Green + Purple & Gray for 0-10V Dimming)

SCL-6FT-SJTW18/6-100FT = 100ft Roll of Black Cord, SJTW 18 AWG 6-Conductor (Black, White, Green + Purple & Gray for 0-10V Dimming + Red for Backup Inverter)

SCL-AH = Heavy-Duty Auxiliary Hook for Up To 1/16" Aircraft Cable

SCL-ASC-500FT = 1/16" 500 ft. Steel Aircraft Cable Suspension

* More Mounting Options Refer to page 4

Factory-Installed Options:

Blank = No Option For Accessories

OPT-HBC-125BS-WH = 10FT, 15A, 125V, 18/3 STR, WHT

* More Factory-Installed Options Refer to page 6

SUSPENDED MOUNTING ACCESSORIES (NOT INCLUDED)



SCL-CS1-6FT SCL-CS1P-6FT SCL-CS1P-6FT-NC



SCL-6FT-SJTW18/5-100FT
SCL-6FT-SJTW18/6-100FT



SCL-GS10



SCL-GS20



SCL-AH



SCL-ASC-500FT



SCL-6FT-SJTW18/5-100FT-BK



SCL-6FT-SJTW18/5



SCL-ASC-500FT

FACTORY-INSTALLED OPTIONS:



OPT-HBC-125BS-WH



MOUNTING AND MODULES OPTIONS:



Recessed Mounted
(Flanged)



Surface Mounted



Wall Mounted



Suspended



T-Bar Installation

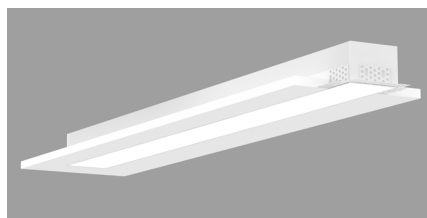

Flangless Recessed Mounted
(Mud-In)

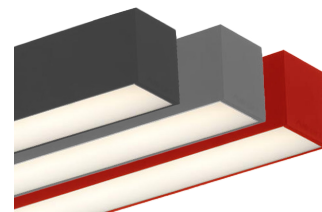

Color of Your Choice

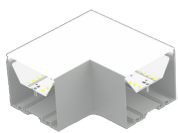

L Module
(page 7)

SCX4-L-MCT4



T Module
(page 7)

SCX4-T-MCT4

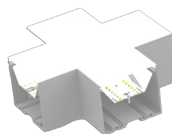

X Module
(page 7)

SCX4-X-MCT4



Inside Corner Module
(page 7)

SCX4-IC-MCT4

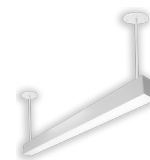

Suspension Rod Kit

- SCL-RS-12 12"
- SCL-RS-18 18"
- SCL-RS-24 24"
- SCL-RS-36 36"
- SCL-RS-48 48"

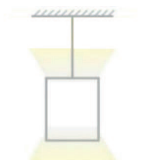

Up Light Option

- 3000K
- 3500K
- 4000K
- 5000K
- Blue
- Green



MOUNTING OPTIONS:

FLANGLSS RECESSED INSTALLATION IN WOOD CEILING

No additional accessories required.

Make recessed preparations by installing a horizontal plank of wood on top of the wood ceiling at a recessed height of 3 3/8".

Screw and anchor kit provided with each fixture can be used to fasten the top of the fixture to the wood plank through the holes on top of the fixture.

You can also install vertical wood boards on top of the ceiling at the edge of the opening and open the fixture and put screws through the side of the fixture housing to fasten it to the wood boards.

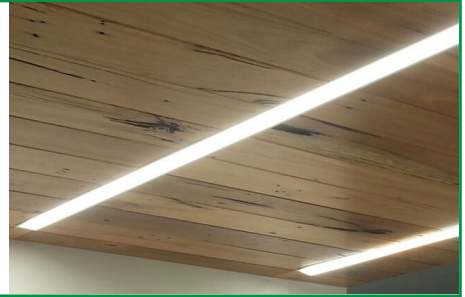

SUSPENSION ROD KITS (SET OF 2)

Model	SIZE
SCL-RS-12	12 IN
SCL-RS-18	18 IN
SCL-RS-24	24 IN
SCL-RS-36	36 IN
SCL-RS-48	48 IN

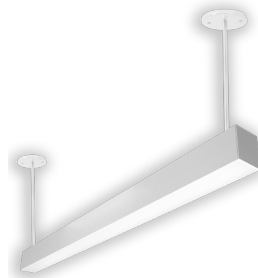

WALL MOUNTING

Model	DESCRIPTION
OPT-SCX-WM-2FT	Install this optional wall mounting brackets on the back of the fixture. Connection cables will enter the fixture through one of these wall-mounting brackets. On your purchase order, please specify the position of where your wire entry from the wall.

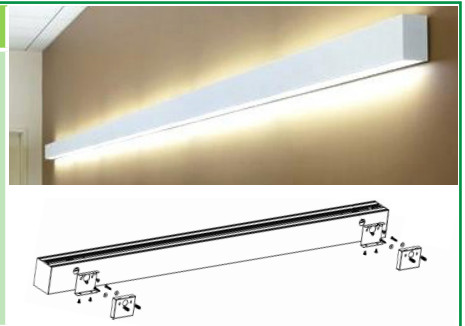

RECESSED MOUNT WITH FLANGE

Model	DESCRIPTION
OPT-SCX-FMR-2FT	Order this option and the fixture will be equipped with a 1/2" wide flange on four sides. Advanced design toggle-style brackets will also be provided, to adjust and hold the fixture against drywall or other hard ceilings from the top. When linking to another fixture or corner module, call us or send a copy of your plan along with your PO, and flanges will be removed on those ends that need to make a seamless connection.

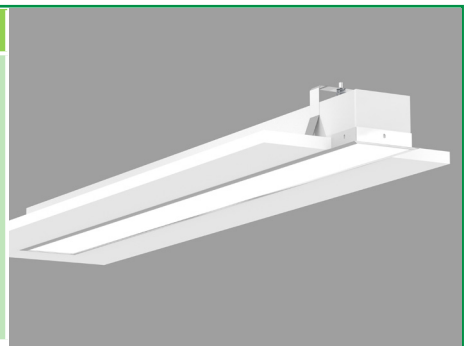

LINKING

Model	DESCRIPTION
OPT-SCX-LINKWIRING	Fixtures are equipped with pre-installed linking brackets and accessories and only need to be wired together. to receive a fixture prewired for linking, order the option below for each link to another fixture or a corner module.



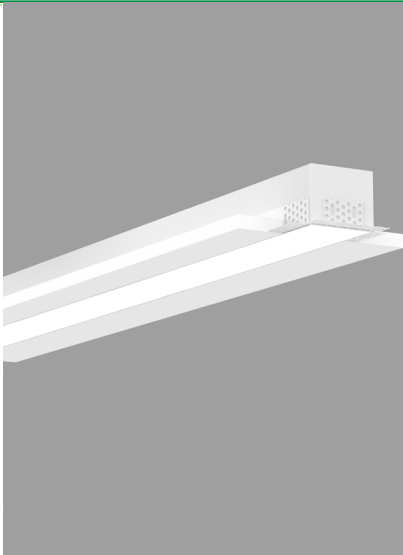

FLANGELESS RECESS MOUNT IN DRYWALL (MUD-IN)

Model	DESCRIPTION
OPT-SCX-MIF-2FT	Order this option and the fixture will be equipped with mud-in brackets on all four sides, mounted at 1/16" from the lens surface (specify if other spacing is needed). Advanced design toggle-style brackets will also be provided, to adjust and hold the fixture against the drywall ceiling from the top. When linking to another fixture or corner fixture module call us or send a copy of your plan along with your PO and flanges will be removed on those end that needs to make a seamless connection.
OPT-SCX-MIF-L	This is a L Module option.
OPT-SCX-MIF-T	This is a T Module option.
OPT-SCX-MIF-X	This is a X Module option.
OPT-SCX-MIF-IC	This is a Inside Corner Module option.



T-BAR INSTALLATION

Model	DESCRIPTION
OPT-SCX-TBAR-2FT	Add this option and 1/2" wide flanges will be installed on the two long sides of the fixture. The two ends of the fixture will fall onto the T-bar grids and will be supported this way. The T-bar tiles on the two sides of the fixture must be cut to allow for the width of the fixture. The tile will fall onto and be supported by the flanges on both sides of the fixture. If you plan to support the fixture by the grids on three sides and tile on one side, call us or specify on your PO, and flange will be installed only on one side of the fixture. To provide safety and support from the beams above the T-bar ceiling order 10ft or 20ft aircraft suspension kits below.
SCL-GS10	Adjustable 1/16" 10ft suspension kit with loop gripper & toggle ends hold up to 70 lbs load.
SCL-GS20	Adjustable 1/16" 20ft suspension kit with loop gripper & toggle ends hold up to 70 lbs load.
OPT-FWH-63	This is a 6FT 3-Wire Whip option.
OPT-FWH-65	This is a 6FT 5-Wire Whip option.
OPT-FWH-66	This is a 6FT 6-Wire Whip option.

SURFACE MOUNTING

<p>No additional accessories required.</p> <p>Screw and anchor kit provided with each fixture can be used to fasten the fixture directly to the hard surface through the holes on top of the fixture.</p>	
---	---

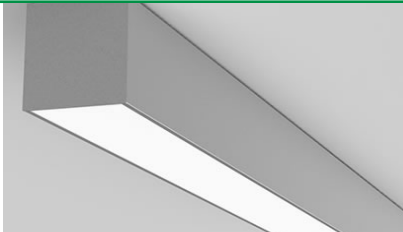

LIGHTS SCX FLEXIBLE LENS ROLL 25FT OR 100FT

Model	SIZE	DESCRIPTION
SCX-FLEXLENS-25FT	25FT	Flex lenses can be cut to different lengths, enabling precise customization according to the installation area. This allows for a seamless fit, reducing gaps or visible transitions between different sections of the SCX lights
SCX-FLEXLENS-100FT	100FT	



FACTORY-INSTALLED OPTIONS:

COLOR OF YOUR CHOICE

Model	DESCRIPTION
OPT-SCX-CLR-2FT	Add this option and specify your desired color on your purchase order or provide a swatch to match. For painted flanged fixture or optional rod, mounting set please also add the relevant option below for each fixture.
OPT-SCX-CLR-FRM	This is a painted flanges option.
OPT-SCX-CLR-RODSET	This is a painted rod set option.

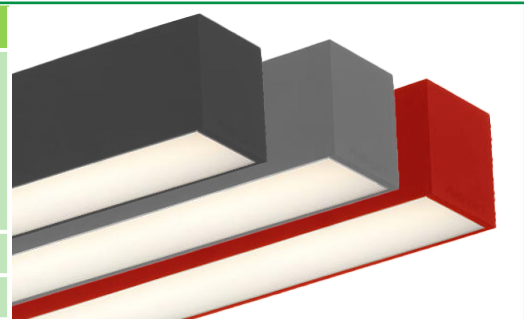

INDIRECT (UP) LIGHTING

Model	WATTS	LUMENS	COLOR TEMP	SIZE
OPT-SCX-ULM-2FT-8W-MCT4	8W	800LM	3000K	2FT
		824LM	3500K	
		840LM	4000K	
		864LM	5000K	
OPT-SCX-ULM-BU	Indirect (up) light with blue color			
OPT-SCX-ULM-GR	Indirect (up) light with green color			

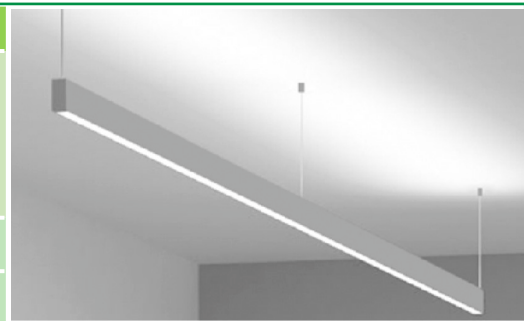

EMERGENCY BATTERY BACKUP

Model	DESCRIPTION
OPT-EM-CM1INT	This is an option for a 90-minute backup battery installation. If you need to order this series for the fixture, please have your purchase order ready and call us or specify on the order which fixture to install this option and the test button.

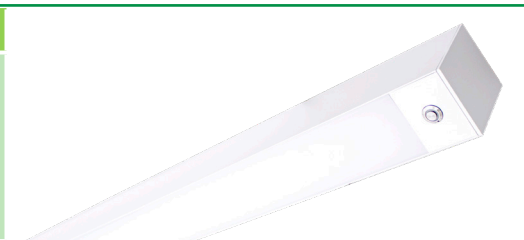

BI-LEVEL MOTION SENSOR

Model	DESCRIPTION
OPT-SEN-SCX4	This option installs an advanced motion sensor that will turn the lights on when the area is occupied. When the area is cleared, after a preset hold time of 5 sec or more the lights are dimmed to a standby level of 30% or more. If still no motion is detected, after the standby period, the light is turned off. All setting is programmable with a remote control.
OPT-WEC-3RC	This is an optional remote control for sensor.

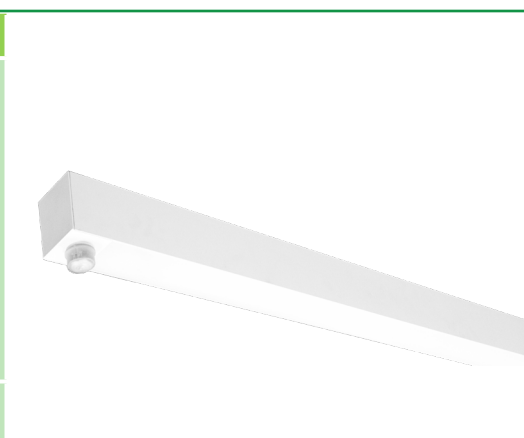

CORNER FIXTURE MODULES:

Built-in LED Modules

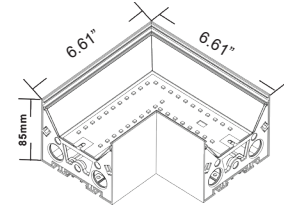
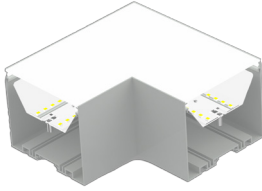

Model	JOINT TYPE	LUMENS	COLOR TEMP	DIMENSION
SCX4-L-MCT4	L	508LM	3000K	3.35" X 6.61" X 6.61"
		575LM	3500K	
		616LM	4000K	
		660LM	5000K	

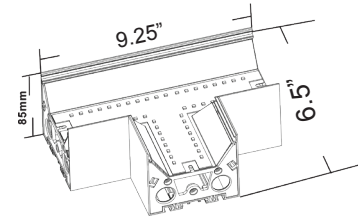
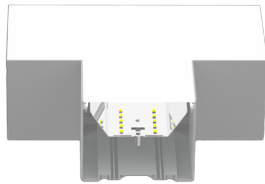

Model	JOINT TYPE	LUMENS	COLOR TEMP	DIMENSION
SCX4-T-MCT4	T	629LM	3000K	3.35" X 9.25" X 6.5"
		726LM	3500K	
		787LM	4000K	
		854LM	5000K	

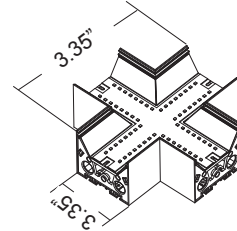
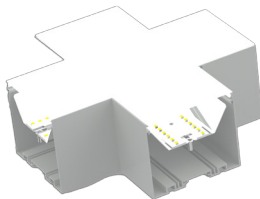

Model	JOINT TYPE	LUMENS	COLOR TEMP	DIMENSION
SCX4-X-30K	X	733LM	3000K	3.35" X 3.35"
		863LM	3500K	
		944LM	4000K	
		1037LM	5000K	

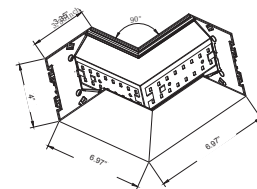
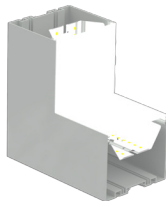

Model	JOINT TYPE	LUMENS	COLOR TEMP	DIMENSION
SCX4-IC-MCT4	INSIDE CORNER	629LM	3000K	3.35" X 4" X 6.97" X 6.97"
		726LM	3500K	
		787LM	4000K	
		854LM	5000K	



DEDICATED WIRING FOR UPLIGHT CONTROL

Model	DESCRIPTION			
OPT-SCX-ULC-2FT-8W-MCT4	Dedicated Wiring For Uplight Control By Installing A Separate Electrical Circuit And Compatible Driver For Uplighting. This Ensures Independent Control And Power Management. A Driver Regulates The Voltage And Current Supplied To The Uplights, Allowing For Precise Brightness And Color Control, Often Through A Dimmer Or automation System.			
	WATTS	LUMENS	COLOR TEMP	SIZE
	8W	800LM 824LM 840LM 864LM	3000K 3500K 4000K 5000K	2FT

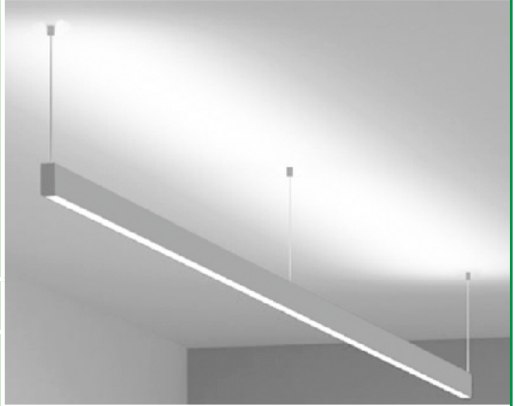

COLOR CHART: * Choose from one of our Premium Colors with no set-up fee.

Gloss:



Hammer:



Texture:



Vein:

